

ST-H3700

SERVICE MANUAL

*E Model
Australian Model
Tourist Model*

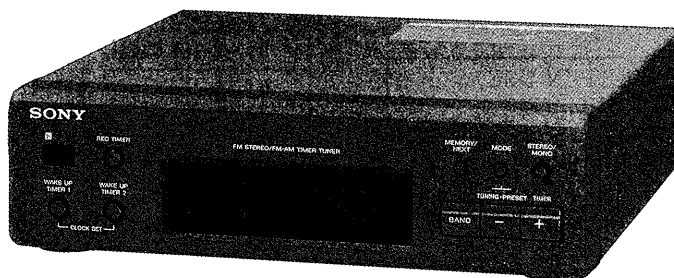

This set is the tuner section in FH-E757

TABLE OF CONTENTS

SPECIFICATIONS	
System	FM stereo, FM/MW/SW superheterodyne tuner
FM tuner section	
Tuning range	87.5 — 108 MHz
Antenna terminals	75 ohm unbalanced
Intermediate frequency	10.7 MHz
AM tuner section	
Tuning range	MW: 531—1,602kHz SW: 3.20—7.30MHz 9.50—21.75MHz
Antenna	AM loop antenna, External antenna terminals
Intermediate frequency	450 kHz

Design and specifications subject to change without notice.

<u>Section</u>	<u>Title</u>	<u>Page</u>
1. SERVICING NOTES		
1-1.	Supply of Power During Services	2
1-2.	Service Mode to Check Timer ON-OFF	2
1-3.	Service Mode to Check FL Tube and Key Input ..	3
1-4.	How to Forcefully Turn Power ON	3
2. GENERAL		4
	Parts Identification	4
	Clock Setting	4
	Tuning in Automatically	5
	Tuning in Manually	5
	Storing Stations	6
	To Tune in a Preset Station	6
3. ELECTRICAL ADJUSTMENTS		7
4. DIAGRAMS		
4-1.	Block Diagram	9
4-2.	Schematic Diagram —Tuner Section—	13
4-3.	Printed Wiring Boards —Tuner Section—	15
4-4.	Schematic Diagram —Display Section—	17
4-5.	Printed Wiring Board —Display Section—	19
4-6.	Pin Description	21
4-7.	Semiconductor Lead Layouts	22
5. EXPLODED VIEW		23
6. ELECTRICAL PARTS LIST		24

FM STEREO/FM-AM TUNER
SONY®

SECTION 1 SERVICING NOTES

1-1. SUPPLY OF POWER DURING SERVICES

Because the equipment is not provided with any power supply, it is operated with power supplied from the amplifier TA-H2700 used in the series. The equipment requires the following 4 types of voltages. Therefore, connect the equipment to TA-H2700 for services such as repairing with power supplied, because it will be too complicated to supply these voltages individually.

VOLTAGE	MAJOR CIRCUIT IN USE
AC 3.9V	FL tube filament voltage (VF)
DC -24V	Display controller IC701 grid voltage (VG)
DC 5.6V	Display controller IC701, Tuner PLL IC81 Vcc
DC 12V	Tuner RF, FM/AM DET IC21 Vcc

1-2. SERVICE MODE TO CHECK TIMER ON-OFF

It is possible to check whether the timer normally functions while being connected with an amplifier.

- (1) Connect the equipment to the amplifier TA-H2700 and set the SYSTEM POWER switch to STANDBY state.
- (2) Set the time of the tuner to any time.
- (3) Press 3 switches "BAND", "-" and "MEMORY/NEXT" at the same time (while pressing "BAND" and "-" beforehand, finally press "MEMORY/NEXT")
- (4) FL display tube

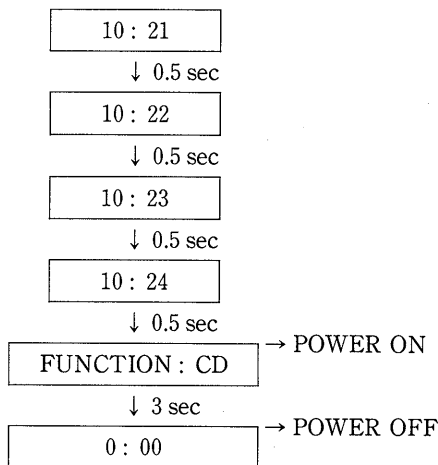

- (5) Completion

Note : After completion of the checking above, data preset in the memory IC702 is erased while resetting the memory to the next page state upon shipping from the works, so be sure to recover the same frequency as that before the repairing.

• Frequencies initially preset

	FM	MW		SW
		9kHz STEP	10kHz STEP	
1	87.5MHz	531kHz	530kHz	3.20MHz
2	88.0MHz	603kHz	620kHz	3.50MHz
3	98.0MHz	999kHz	1050kHz	5.00MHz
4	100.0MHz	1404kHz	1490kHz	6.50MHz
5	108.0MHz	1602kHz	1710kHz	7.30MHz
6				9.50MHz
7				10.00MHz
8	*1	*2	*2	15.00MHz
9				20.00MHz
10				21.75MHz
11-20	*1	/	/	/

- *1 The same frequency values are set for the preset memory No.6-No.10, No.11-No.15 and No.16-No.20 as for No.1-No.5 respectively.
- *2 The same frequency values are set for the preset memory No.6-No.10 as for No.1-No.5.

1-3. SERVICE MODE TO CHECK FL TUBE AND KEY INPUT

It is possible to check FL tube all ON grid, segment and key input.

- (1) Connect the equipment to the amplifier TA-H2700 and remove the AC cord of the amplifier out of the AC receptacle.
- (2) While pressing 3 switches "BAND", "-" and "MEMORY/NEXT" at the same time, insert the AC cord of the amplifier into the receptacle.
- (3) Thus, all FL display tubes light up. By pressing "+" or "TIMER CONTROL" in this state, partial lighting or key input checking, respectively, is effected.

Partial lighting : Indicates the mode to check complete connection between the grid and segment of the FL tube. The condition is normal when the following indication is effected. By pressing "+" or "-" in the partial lighting mode, the status returns to key input checking or all ON in (3), respectively.

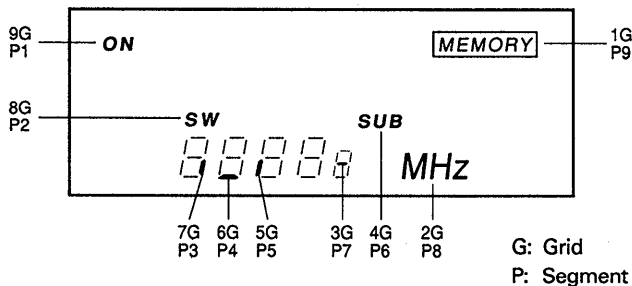

Key input checking : Shows the mode to check key input into 9 keys on the front panel. "0" is indicated at first, and every time a different key is pressed, indicated number is increased. After completion of pressing all 9 keys, "PASS" is indicated.

(Once a key is pressed, pressing it again is rejected.)

- (4) After the completion of the checking, the equipment recovers normal operation by once removing the AC cord and inserting it again into the AC receptacle.

1-4. HOW TO FORCEFULLY TURN POWER ON

The equipment is not provided with any power switch. Therefore, power ON/OFF is controlled in the amplifier side. However, even without an amplifier, power is supplyable to the equipment according to the following methods provided any type of power is available, e.g. using a special jig or supplying the 4 types of voltages individually.

(When power is supplied from the amplifier, power is turned ON only for the tuner.)

- (1) Supply power.
- (2) Press 3 switches "STEREO/MONO", "-" and "MEMORY/NEXT" at the same time.
(Press "STEREO/MONO" and "-" beforehand, and finally press "MEMORY/NEXT".)

However, when the equipment is started up by the methods above, service modes TIMER ON/OFF and FL tube and key input checking are not operable.

SECTION 2 GENERAL

This section is extracted from instruction manual.

Parts Identification

Refer to the pages indicated in ● for use of the buttons.

Tuner Section A

- 1 Remote control sensor
- 2 REC TIMER button
- 3 Display window
- 4 MEMORY/NEXT button
- 5 MODE button
- 6 STEREO/MONO (stereo/monaural) button
- 7 TUNING/PRESET indicator
- 8 TUNING PRESET/TIMER +/- buttons
- 9 BAND selector
- 10 WAKE UP TIMER 1, 2 /CLOCK SET buttons

A

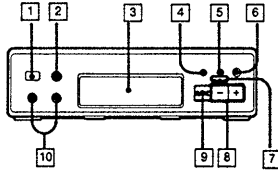

Clock Setting

Setting the Clock

Example: Set to 9:25 in the morning.

- 1 Press WAKE UP TIMER 1 and 2 at the same time.
- 2 Set the hour with the - or + button.
- 3 Press MEMORY/NEXT.
- 4 Set the minute with the - or + button.
- 5 Press MEMORY/NEXT. The clock starts operating.

Information on the time

The European model shows the time in 24-hour cycle.
The model for other countries shows the time in 12-hour cycle.
AM 12:00 = midnight
PM 12:00 = noon

When a power interruption occurs

The clock, timer and Wake Up Volume settings are all erased, and "0:00" ("AM 12:00") will flash on the display.

To change the frequency display to the time display

Press CLOCK DISPLAY on the remote commander. Press it again to change to the frequency display.

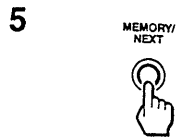
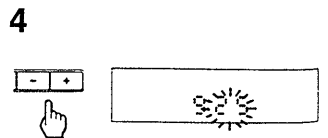
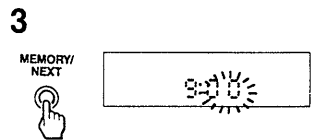
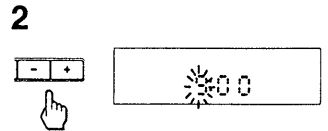
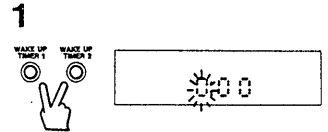
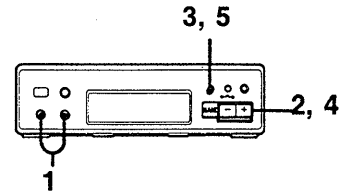
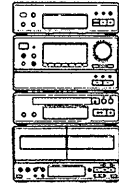

Radio

The automatic tuning allows you to receive stations whose signal is strong enough. When the signal is too weak, use the manual tuning.

Tuning in Automatically

- 1 Press **BAND** repeatedly until the desired band appears.

As you press **BAND**, the band changes as follows:

European model:
FM → MW → LW

Model for other countries:
FM → MW → SW

- 2 Press **MODE** so that the **TUNING** indicator lights up.

- 3 Keep **-** or **+** depressed for more than 1 second. "AUTO" appears on the display and the unit tunes in a station automatically.

Repeat step 3 until the desired station appears.

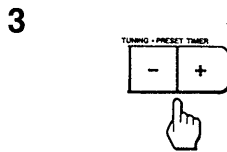
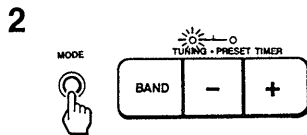
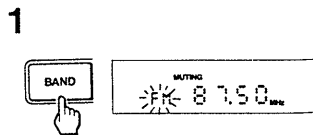
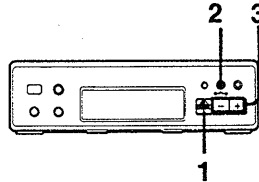
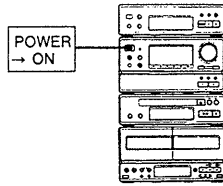

Radio

Tuning in Manually

- 1 Press **BAND** repeatedly until the desired band appears.
- 2 Press **MODE** so that the **TUNING** indicator lights up.
- 3 Press **-** or **+** repeatedly until the desired station appears.

Indicator on the display

TUNED: Appears when a station with sufficient signal strength is tuned in.

STEREO: Appears when an FM stereo program with sufficient signal strength is received.

Antenna adjustment **A**

For MW and LW (SW) reception, find the best location for the supplied AM loop antenna.

When an FM program is noisy or hard to receive

Press **STEREO/MONO** so that "MONO" appears in the display. There will be no stereo effect, but the reception will be improved. Press the button again to restore the stereo effect.

Changing the MW tuning interval (except for the European model)

The MW tuning interval is preset at the factory to 9 kHz.

If you use the system where the frequency allocation system is different from the preset interval, change the interval as follows.

- 1 Turn on the power.
- 2 Tune in an MW station.
- 3 Disconnect the AC power cord.
- 4 Connect the AC power cord again while pressing **TUNING +**.

To reset the interval, follow the same procedure.

Important

When the interval is changed, stored stations will be erased from the memory.

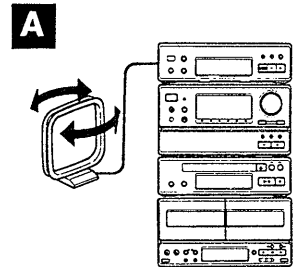
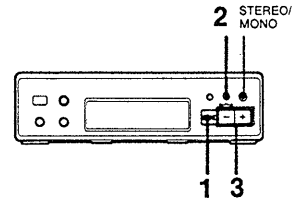

Radio

Storing Stations

You can store up to 20 FM stations and 10 MW stations and 10 LW (SW) stations in a desired sequence, so that you can tune in the stored station directly by entering the preset station number. This operation is not possible with the remote commander.

- 1 Tune in the desired station.
 - 2 Press MEMORY/NEXT. "MEMORY" and the preset station numbers appear on the display.
 - 3 While "MEMORY" is on (for several seconds), press - or + to select a desired preset number.
 - 4 Press MEMORY/NEXT. "MEMORY" disappears, and the station is stored.
- Repeat step 1 to 4 for each station to be stored.

If you cannot store a station successfully
Press MEMORY/NEXT again so that "MEMORY" appears, and then proceed with steps 3 and 4 above. Be sure to operate while "MEMORY" is on (about 4 seconds).

When you have selected the wrong preset station number
Press MEMORY/NEXT again and then proceed with the steps 3 and 4.

To change the preset station
Store a desired station at the desired preset number by proceeding with the above steps. The station previously preset will be erased. Erasing only is not possible.

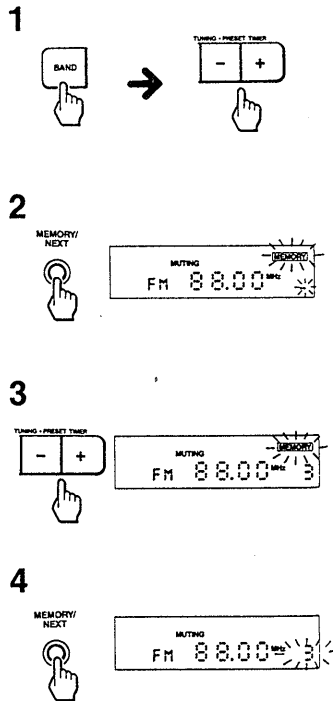
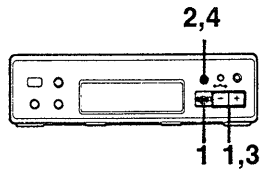

Radio

To Tune in a Preset Station

- 1 Press BAND to select a desired band.
- 2 Press MODE so that the PRESET indicator lights up.
- 3 Press - or + to select the desired preset station number.

To tune in a preset station directly

- Possible only with the remote commander.
- 1 Set the TUNER/EQ/CD numeric button function selector to TUNER.
 - 2 Press BAND to select a desired band.
 - 3 Press the numeric buttons to select the desired preset station number.

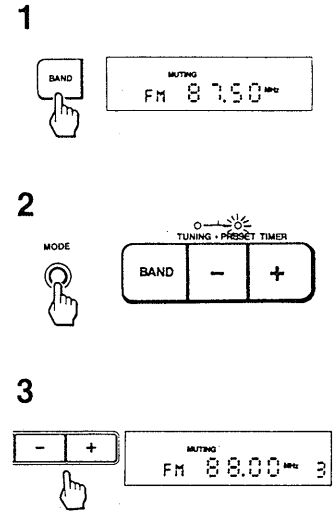
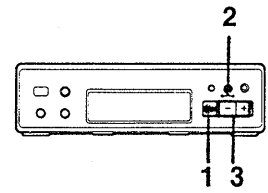

SECTION 3 ELECTRICAL ADJUSTMENTS

Precautions in Repairing

If the front end unit fails, it is difficult to repair the inner circuits, so replace the entire front end unit.

FM SECTION

FM Discriminator Adjustment (NULL Adjustment)

Setting :
BAND : FM

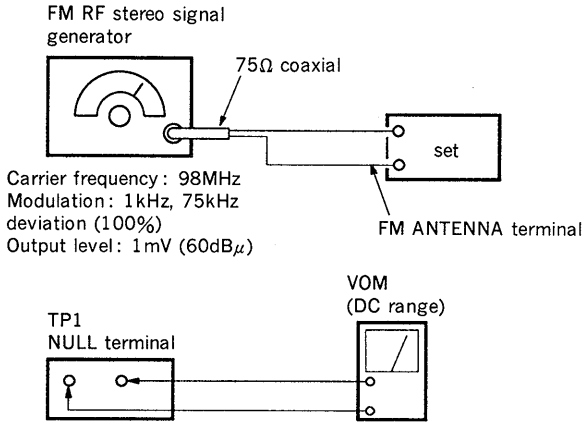

Procedure :

1. Tune the set to 98MHz.
2. Adjust T21 for 0V reading on the VOM.

Note : FM Tuning Level adjustment should be made after FM discriminator alignment.

FM Tuning Level Adjustment

Setting :
BAND : FM

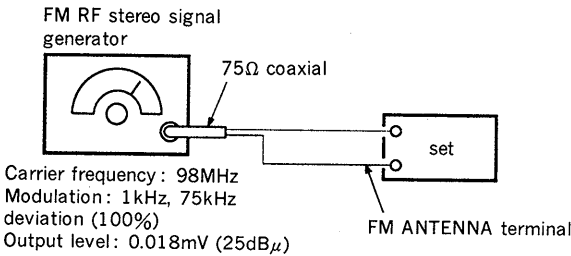

Procedure :

1. Tune the set to 98MHz.
2. Adjust RV23 so that the TUNED indicator goes on.

FM Stereo Separation Adjustment

Setting :
BAND : FM

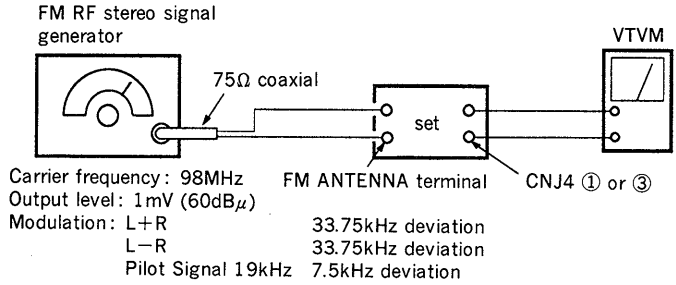

Procedure :
Tune the set to 98MHz.

FM stereo Signal generator Output channel	VTVM connection	VTVM reading (dB)
L-CH	L-CH	Ⓐ
R-CH	L-CH	Ⓑ Adjust RV21 for minimum reading.
R-CH	R-CH	Ⓒ
L-CH	R-CH	Ⓓ Adjust RV21 for minimum reading.

L-CH Stereo separation : Ⓐ—Ⓑ
R-CH Stereo separation : Ⓒ—Ⓓ

The separations of both channels should be equal.

AM SECTION

AM Tuning Level Adjustment

Setting :
BAND : MW

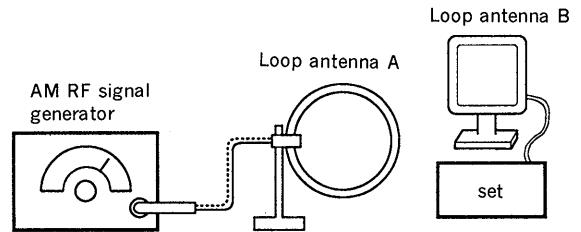

Carrier frequency: 999kHz
30% amplitude modulation by 400Hz signal

Procedure :

1. Set loop antenna A so that the loop antenna B input level becomes 58dB μ /m (0.8m V/m)
2. Tune the set to 999kHz.
3. Adjust the RV22 so that the TUNED indicator goes on.

**SW1/SW2 Control Voltage Adjustment
(Frequency Coverage Adjustment)**

Setting :

BAND: SW

Procedure :

1. Connect digital voltmeter to diode D77 center lead and ground.
2. Adjust for a following value reading on digital voltmeter.

	Set frequency	Adjustment part	Reading on digital voltmeter
SW1	f min. 3.2MHz	T62	1.05V
	f max. 7.3MHz	CT62	8.7V
SW2	f min. 9.5MHz	T64	1.05V
	f max. 21.75MHz	CT64	8.7V

SW1/SW2 Tracking Adjustment

Setting :

BAND: SW

AM RF signal generator

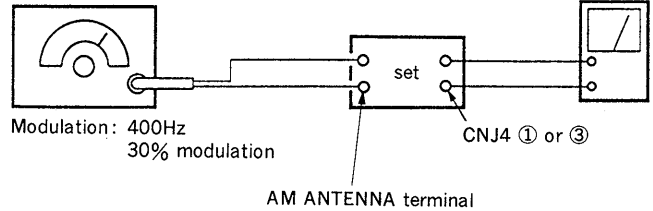

Procedure :

Adjust for a maximum reading on VTVM.

	Set frequency	Adjustment part
SW1	f low. 3.5MHz	T61
	f high. 6.5MHz	CT61
SW2	f low. 10.0MHz	T63
	f high. 20.0MHz	CT63

- Repeat the procedures is each adjustment several times, and the frequency coverage and tracking adjustments should be finally done by the trimmer capacitors.

Adjustment Location :

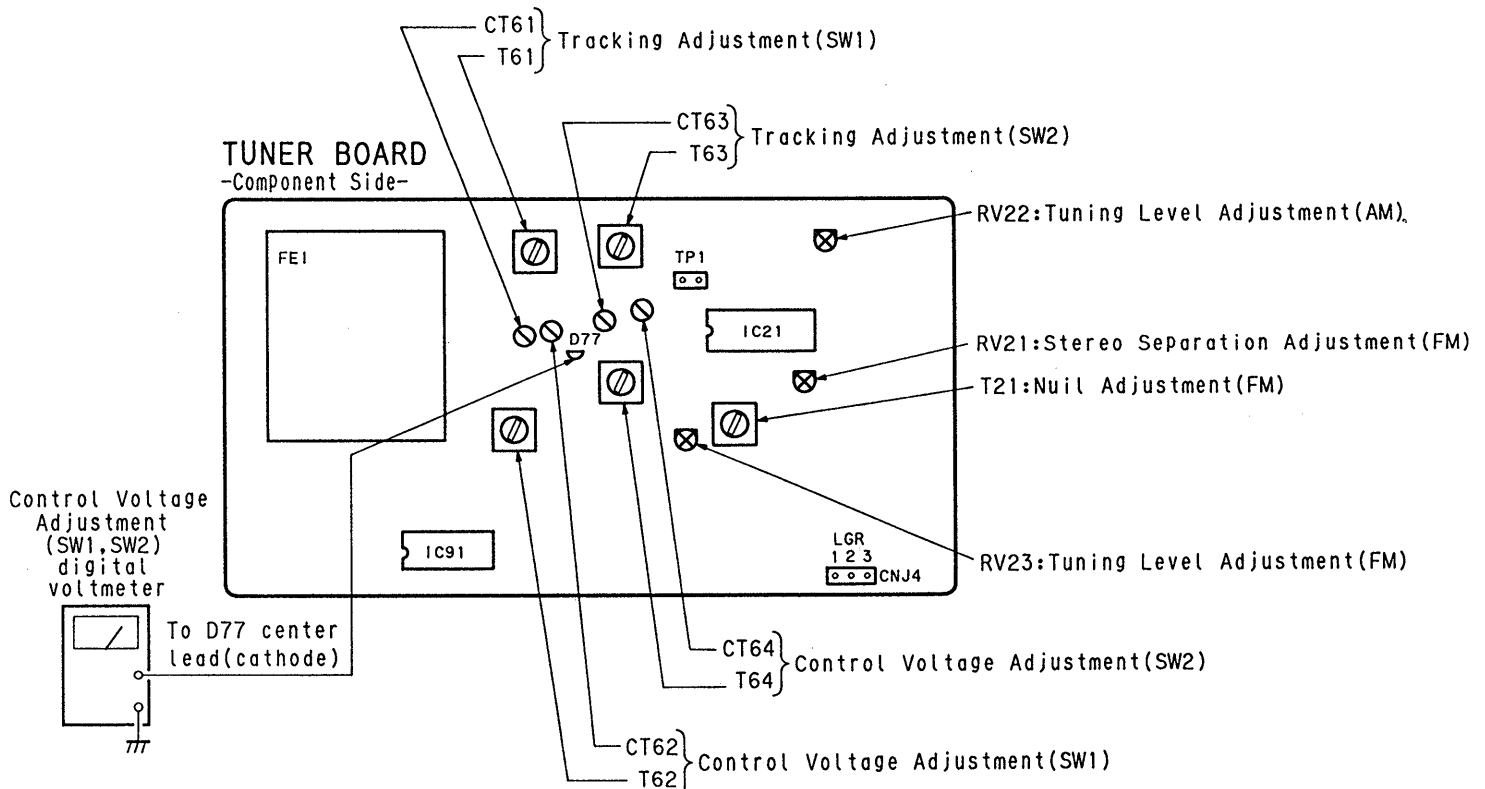

SECTION 4
DIAGRAMS

4-1. BLOCK DIAGRAM

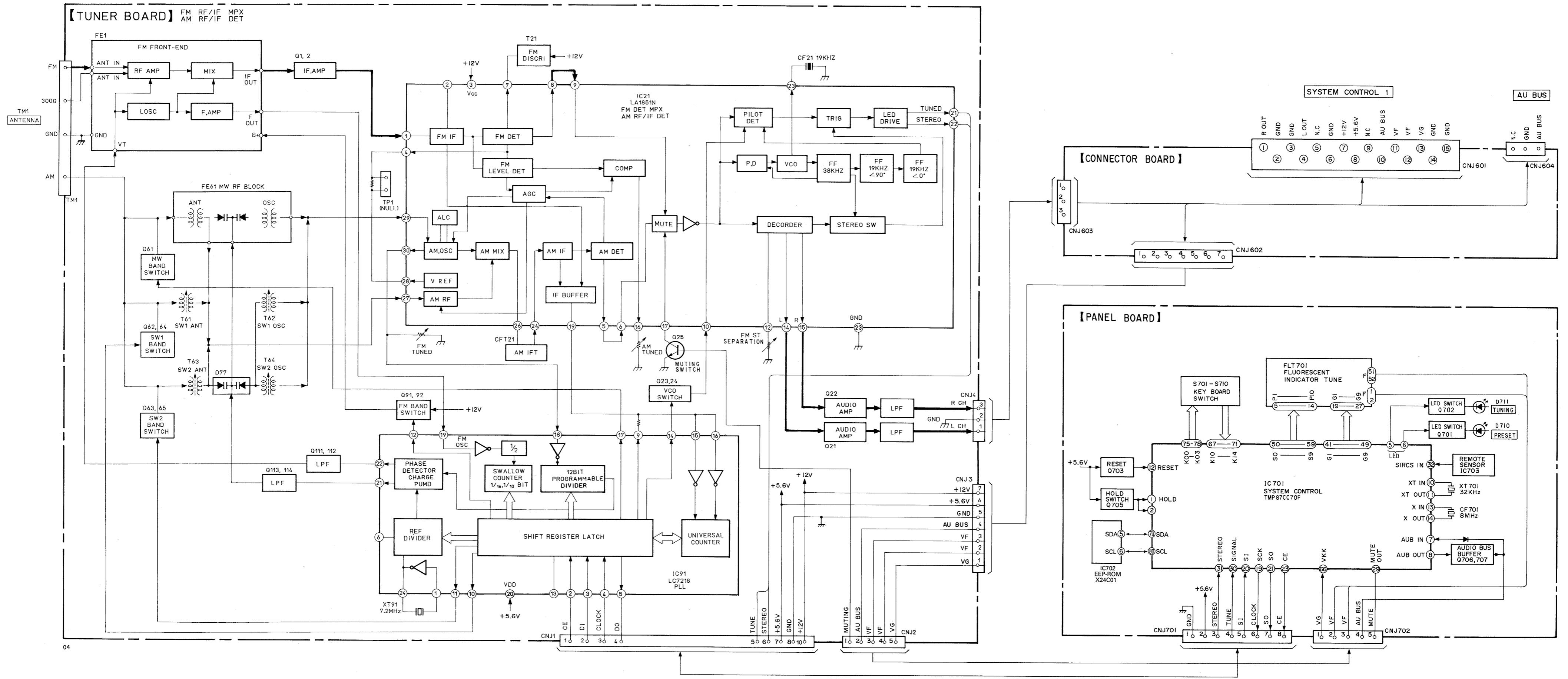

4-2. SCHEMATIC DIAGRAM—TUNER SECTION—

• IC Block Diagrams

IC21 LA1851N

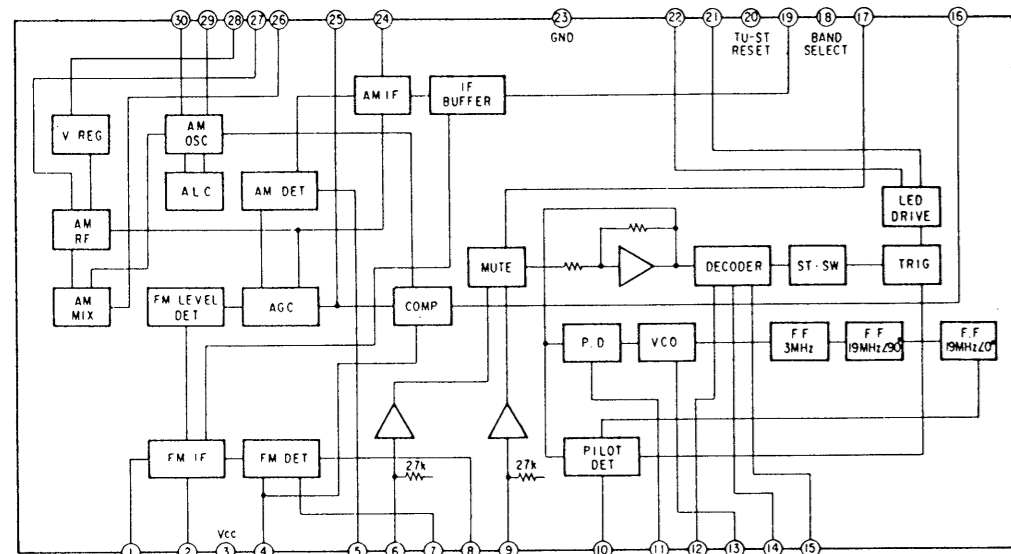

IC81 LC7218

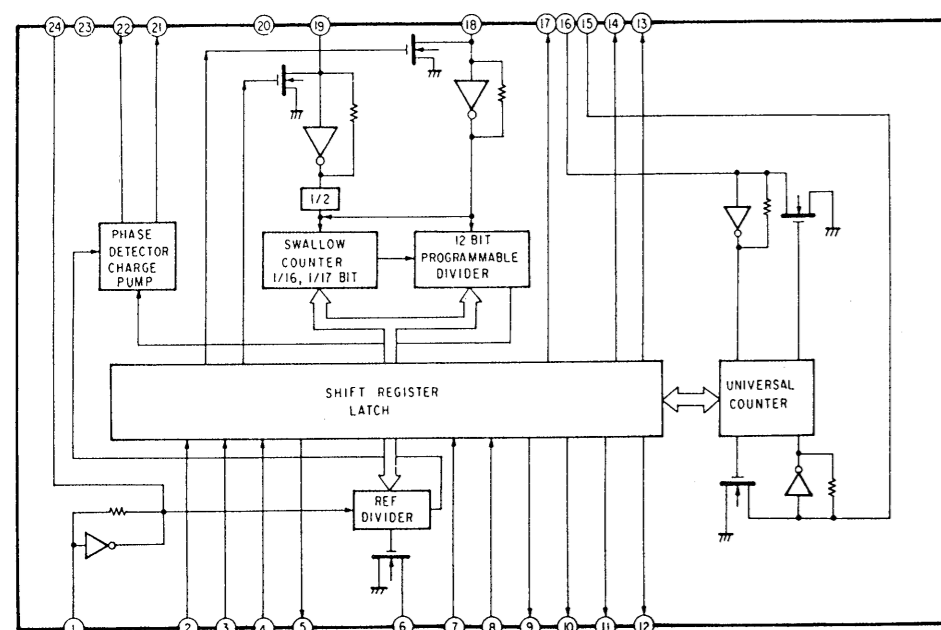

Note:

- All capacitors are in μF unless otherwise noted. pF : μF 50WV or less are not indicated except for electrolytics and tantalums.
- All resistors are in Ω and $\frac{1}{4}\text{W}$ or less unless otherwise specified.
- \triangle : internal component.
- \square : nonflammable resistor.

Note: The components identified by mark \triangle or dotted line with mark \triangle are critical for safety. Replace only with part number specified.

- \square : adjustment for repair.
- Voltage and waveforms are dc with respect to ground under no-signal (detuned) conditions.
no mark: FM
(): MW
< >: SW
- Voltages are taken with a VOM (Input Impedance $10\text{M}\Omega$). Voltage variations may be noted due to normal production tolerances.
- Waveforms are taken with an oscilloscope. Voltage variations may be noted due to normal production tolerances.
- Signal path.
 \Rightarrow : FM

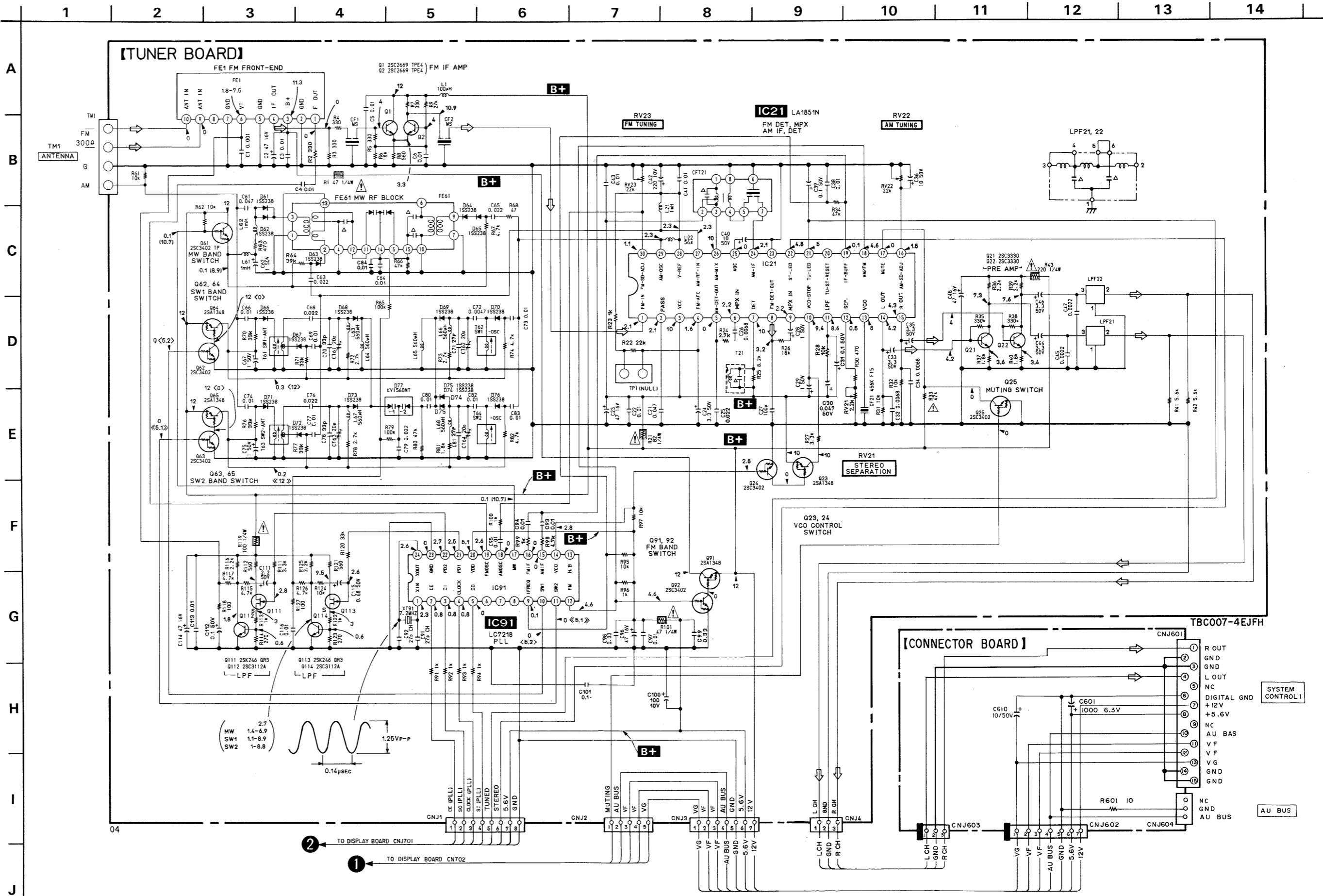

4-3. PRINTED WIRING BOARDS—TUNER SECTION— • Refer to page 22 for Semiconductor Lead Layouts.

• Semiconductor Location

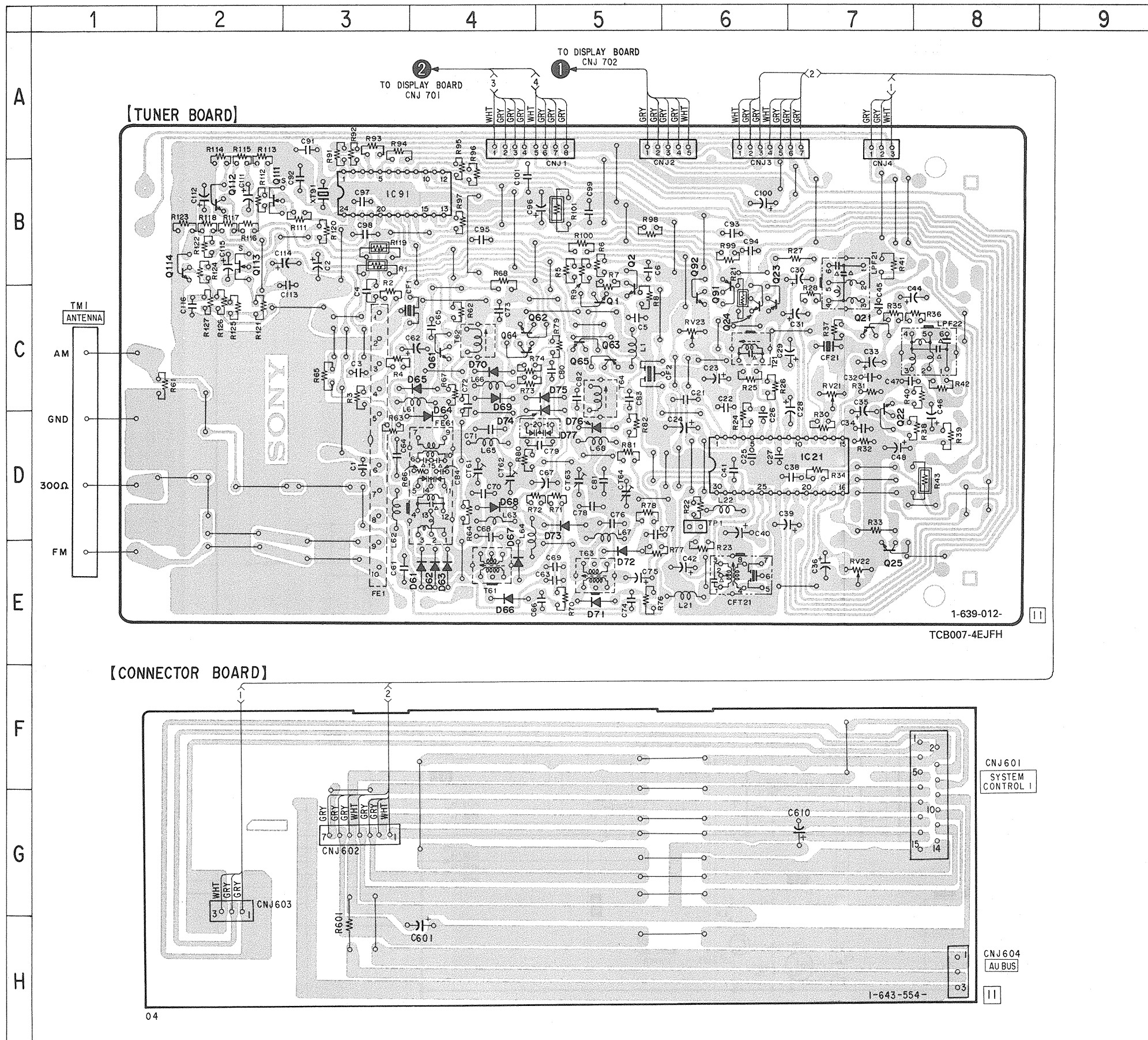

Ref. No.	Location
D61	E-4
D62	E-4
D63	E-4
D64	D-4
D65	C-4
D66	E-4
D67	E-4
D68	D-4
D69	C-4
D70	C-4
D71	E-5
D72	E-5
D73	D-5
D74	C-5
D75	C-5
D76	D-5
D77	D-5
IC21	D-7
IC91	B-3
Q1	C-5
Q2	B-5
Q21	C-7
Q22	D-7
Q23	C-6
Q24	C-6
Q25	E-7
Q61	C-4
Q62	C-4
Q63	C-5
Q64	C-4
Q65	C-5
Q91	C-6
Q92	B-6
Q111	B-2
Q112	B-2
Q113	B-2
Q114	B-2

Note:
 • ○ : parts extracted from the component side.

4-4. SCHEMATIC DIAGRAM—DISPLAY SECTION—

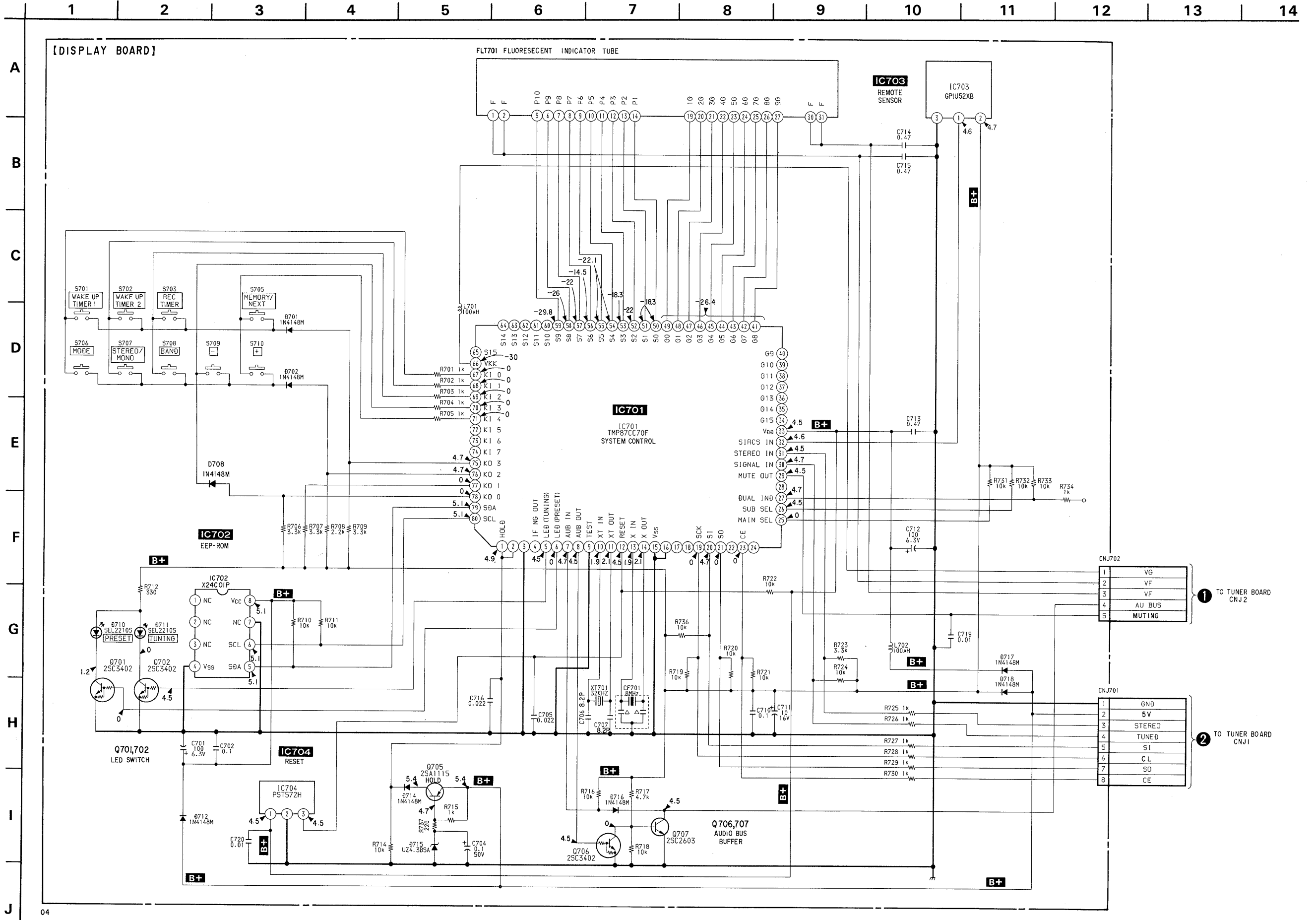

4-5. PRINTED WIRING BOARD—DISPLAY SECTION— • Refer to page 22 for Semiconductor Lead Layouts.

• Semiconductor Location

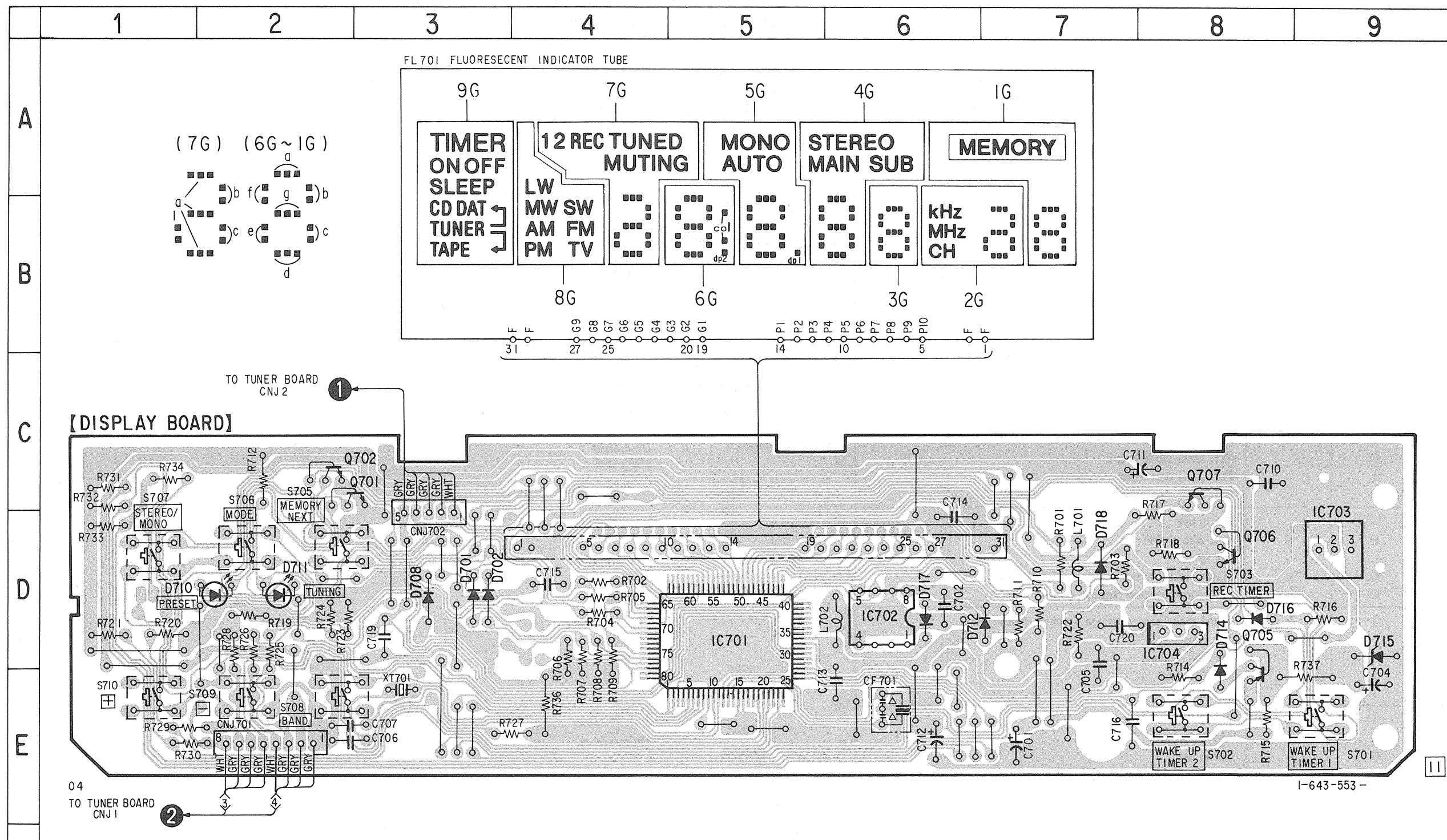

Ref. No.	Location
D701	D-3
D702	D-3
D708	D-3
D710	D-2
D711	D-2
D712	D-6
D714	D-8
D715	D-9
D716	D-8
D717	D-6
D718	D-7
IC701	D-5
IC702	D-6
IC703	D-9
IC704	D-8
Q701	C-2
Q702	C-2
Q705	D-8
Q706	D-8
Q707	C-8

Note on Printed Wiring Board:

• ○ : parts extracted from the component side.

Note on Schematic Diagram:

- All capacitors are in μF unless otherwise noted. pF : $\mu\mu\text{F}$. 50WV or less are not indicated except for electrolytics and tantalums.
- All resistors are in Ω and $\frac{1}{4}\text{W}$ or less unless otherwise specified.
- Δ : internal component.
- Voltage and waveforms are dc with respect to ground under no-signal (detuned) conditions.
- no mark : FM

- Voltages are taken with a VOM (Input Impedance $10\text{M}\Omega$). Voltage variations may be noted due to normal production tolerances.

4-6. PIN DESCRIPTION

● IC701 System Controller (TMP87CC70F)

The terminals work to control tuner section (IC21, 81), FL tube display and reading and writing of IC702 (preset data), etc. according to key input and signal from the remote controller.

PIN No.	PIN NAME	I/O	ACTIVE	PIN FUNCTION
1	HOLD	I	↓	HOLD detecting interrupt terminal
2	HOLD RESET	I	↑	HOLD resetting interrupt terminal
3		I		Not in use
4	IF NGOUT	O	H	IF count NG output
5	LED1	O	H	TUNING LED ON
6	LED2	O	H	PRESET LED ON
7	AUB IN	I	L	AUDIO BUS input
8	AUB OUT	O	L	AUDIO BUS output
9	TEST	I	H	Test terminal
10	XT IN	I		Low frequency oscillator connection terminal (32KHz)
11	XT OUT	O		Low frequency oscillator connection terminal (32KHz)
12	RESET	I	L	Reset signal input
13	X IN	I		High frequency oscillator connection terminal (8MHz)
14	X OUT	O		High frequency oscillator connection terminal (8MHz)
15	VSS			GND
16		I		Not in use
17, 18		O		Not in use
19	SCK	O		PLL serial clock output
20	SI	I		PLL serial data input
21	SO	O		PLL serial data output
22				Not in use
23	CE	O	H	PLL chip enable
24				Not in use
25	MAIN SEL	O	L	Main sound selection terminal (Not in use)
26	SUB SEL	O	L	Sub sound selection terminal (Not in use)
27	DUAL IND	I	L	Sound dual signal detection terminal (Not in use)
28				Not in use
29	MUTE OUT	O	L	MUTING output
30	SIGNAL IN	I	L	TUNED input
31	STEREO IN	I	L	STEREO input
32	SIRCS IN	I	L	SIRCS input
33	VDD			+5V
34 - 40		O		Not in use
41 - 49	G0 - G8	O	H	FL tube digit output
50 - 59	S0 - S9	O	H	FL tube segment output
60 - 65		O	H	Not in use
66	VKK			FL tube driving power supply
67 - 71	KI0 - KI4	I	H	Key input
72		I		Not in use
73, 74				Not in use
75 - 78	KO0 - KO3	O	H	Key output
79	SDA	I/O		Data input/output for EEPROM
80	SCL	O		Clock output for EEPROM

4-7. SEMICONDUCTOR LEAD LAYOUTS

GP1U52XB

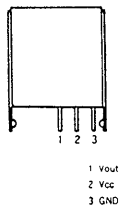

2SA1175-HFE

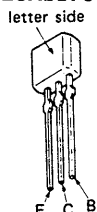

LA1851N

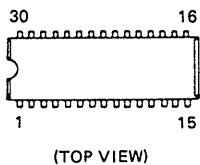

2SC3330-T

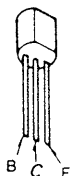

LC7218

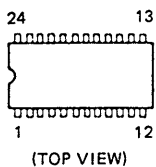

2SK246-GR3

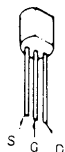

PST572H

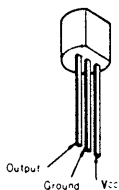

UZ-4.3BSA
1N4148M

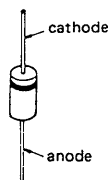

TMP87CC70F

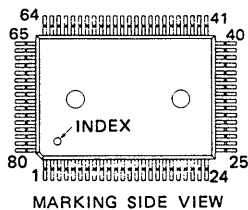

1SS168

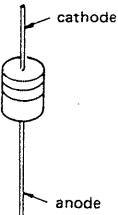

X24C01P

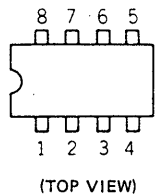

SEL2210S-D

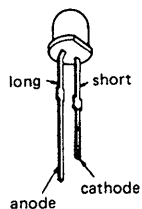

DTA114ES
DTC114ES
2S2603-EF
2SC2669-0Y
2SC3113-AB

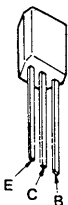

**SECTION 5
EXPLODED VIEW**

NOTE:

- The mechanical parts with no reference number in the exploded views are not supplied.
- Items marked "*" are not stocked since they are seldom required for routine service. Some delay should be anticipated when ordering these items.
- -XX, -X mean standardized parts, so they may have some differences from the original one.
- Color Indication of Appearance Parts
Example:
KNOB, BALANCE (WHITE)...(RED)
↑ ↑
Parts Color Cabinet's Color
- Hardware (# mark) list is given in the last of this parts list.

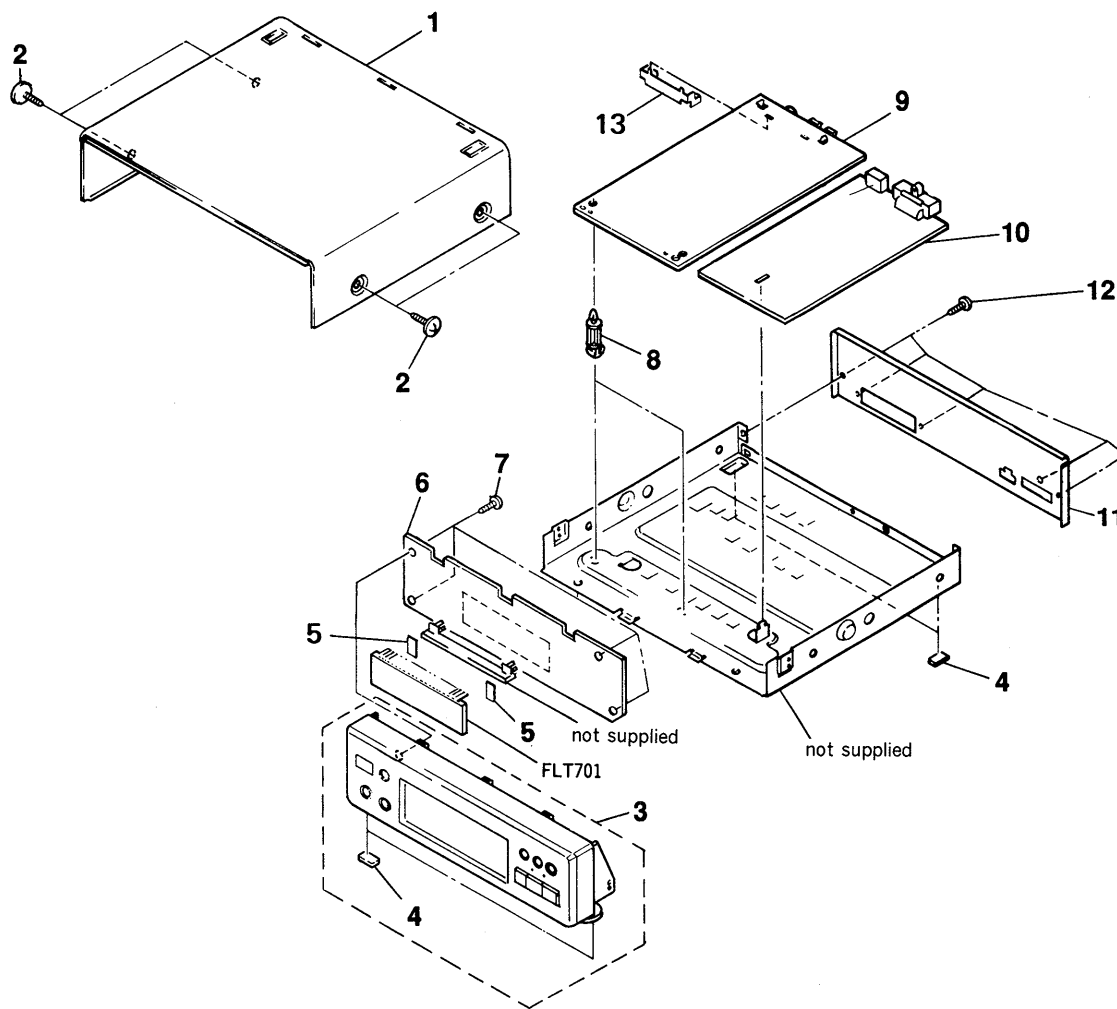

Ref. No.	Part No.	Description	Remark
* 1	4-944-423-41	CASE (K206522)	
2	3-363-099-01	SCREW (CASE +3X8 TP2)	
3	X-4942-571-1	PANEL ASSY, FRONT	
4	4-930-336-21	FOOT (FELT)	
* 5	4-932-810-11	CUSHION (FL)	
* 6	A-4345-968-A	DISPLAY BOARD, COMPLETE	
7	4-928-635-01	SCREW, +BV (2. 6X8) TAPPING	

Ref. No.	Part No.	Description	Remark
* 8	4-914-008-01	HOLDER, PCB	
* 9	A-4303-370-A	TUNER BOARD, COMPLETE (TCB007-4EJFH)	
* 10	1-643-554-11	CONNECTOR BOARD	
* 11	4-948-729-31	PANEL (EXP), BACK	
12	7-685-647-79	SCREW +BVTP 3X10 TYPE2 N-S	
* 13	4-924-988-11	PLATE (ST), GROUND	
FLT701	1-519-709-11	INDICATOR TUBE, FLUORESCENT	

TUNER

SECTION 6
ELECTRICAL PARTS LIST

NOTE:

- Due to standardization, replacements in the parts list may be different from the parts specified in the diagrams or the components used on the set.
- -XX and -X mean standardized parts, so they may have some difference from the original one.
- RESISTORS
All resistors are in ohms.
METAL: Metal-film resistor.
METAL OXIDE: Metal oxide-film resistor.
F: nonflammable

- Items marked "*" are not stocked since they are seldom required for routine service. Some delay should be anticipated when ordering these items.
- SEMICONDUCTORS
In each case, u: μ , for example:
uA.: μ A. uPA.: μ PA.
uPB.: μ PB. uPC.: μ PC. uPD.: μ PD.
- CAPACITORS
uF: μ F
- COILS
uH: μ H

The components identified by mark \triangle or dotted line with mark \triangle are critical for safety. Replace only with part number specified.

When indicating parts by reference number, please include the board.

Ref. No.	Part No.	Description	Remark	Ref. No.	Part No.	Description	Remark
	A-4303-370-A	TUNER BOARD, COMPLETE (TCB007-4EJFH)		C61	1-101-006-00	CERAMIC CHIP	0.47uF 50V
		*****		C62	1-124-903-11	ELECT	1.0uF 20% 50V
*	4-924-988-11	PLATE (ST), GROUND		C63	1-163-063-00	CERAMIC CHIP	0.022uF 25V
		< CAPACITOR >		C64	1-161-379-00	CERAMIC	0.01uF 30% 16V
				C65	1-163-063-00	CERAMIC CHIP	0.022uF 25V
C1	1-162-294-11	CERAMIC CHIP	0.001uF 20% 25V	C66	1-163-059-00	CERAMIC MELF	0.01uF 20% 16V
C2	1-124-119-00	ELECT	330uF 20% 16V	C67	1-124-903-11	ELECT	0.1uF 20% 50V
C3	1-163-059-00	CERAMIC MELF	0.01uF 20% 16V	C68	1-101-005-00	CERAMIC	0.022uF 50V
C4	1-162-294-31	CERAMIC CHIP	0.001uF 20% 25V	C69	1-163-059-00	CERAMIC MELF	0.01uF 20% 16V
C5	1-163-059-00	CERAMIC MELF	0.01uF 20% 16V	C70	1-102-963-00	CERAMIC	33pF 5% 50V
C6	1-163-059-00	CERAMIC MELF	0.01uF 20% 16V	C71	1-102-961-00	CERAMIC	27pF 5% 50V
C7	1-102-942-00	CERAMIC	5pF 0.5pF 50V	C72	1-163-017-00	CERAMIC CHIP	0.047uF 20% 12V
C21	1-101-006-00	CERAMIC	0.047uF 50V	C73	1-163-059-00	CERAMIC MELF	0.01uF 20% 16V
C22	1-163-059-00	CERAMIC MELF	0.01uF 20% 16V	C74	1-163-059-00	CERAMIC MELF	0.01uF 20% 16V
C23	1-124-477-11	ELECT	47uF 20% 25V	C75	1-124-903-11	ELECT	0.1uF 20% 50V
C24	1-123-382-00	ELECT	3.3uF 20% 100V	C76	1-101-005-00	CERAMIC	0.022uF 50V
C25	1-163-063-00	CERAMIC MELF	0.022uF 25V	C77	1-163-059-00	CERAMIC MELF	0.01uF 20% 16V
C26	1-163-019-00	CERAMIC CHIP	0.0068uF 20% 12V	C78	1-102-963-00	CERAMIC	33pF 5% 50V
C27	1-162-516-11	CERAMIC CHIP	100pF 10% 50V	C79	1-101-005-00	CERAMIC	0.022uF 50V
C28	1-124-903-11	ELECT	1.0uF 20% 50V	C80	1-163-059-00	CERAMIC MELF	0.01uF 20% 16V
C29	1-124-903-11	ELECT	1.0uF 20% 50V	C81	1-102-961-00	CERAMIC	27pF 5% 50V
C30	1-124-902-00	ELECT	0.47uF 20% 50V	C82	1-163-059-00	CERAMIC MELF	0.01uF 20% 16V
C31	1-124-463-00	ELECT	0.1uF 20% 50V	C83	1-163-059-00	CERAMIC MELF	0.01uF 20% 16V
C32	1-130-481-00	CERAMIC CHIP	0.0068uF 20% 12V	C84	1-163-059-00	CERAMIC MELF	0.01uF 20% 16V
C33	1-123-382-00	ELECT	3.3uF 20% 50V	C91	1-102-961-00	CERAMIC	27pF 5% 50V
C34	1-130-481-00	CERAMIC CHIP	0.0068uF 20% 12V	C92	1-102-961-00	CERAMIC	27pF 5% 50V
C35	1-123-382-00	ELECT	3.3uF 20% 50V	C93	1-163-059-00	CERAMIC MELF	0.01uF 20% 16V
C36	1-124-907-11	ELECT	10uF 20% 50V	C94	1-163-059-00	CERAMIC MELF	0.01uF 20% 16V
C38	1-163-059-00	CERAMIC MELF	0.01uF 20% 16V	C95	1-163-095-00	CERAMIC MELF	0.01uF 20% 16V
C39	1-124-463-00	ELECT	0.1uF 20% 50V	C96	1-124-477-11	ELECT	47uF 20% 16V
C40	1-124-907-11	ELECT	10uF 20% 50V	C97	1-163-059-00	CERAMIC MELF	0.01uF 20% 16V
C41	1-163-059-00	CERAMIC MELF	0.01uF 20% 16V	C98	1-163-171-00	CERAMIC MELF	0.33uF 5% 50V
C42	1-126-176-11	ELECT	220uF 20% 10V	C99	1-163-171-00	CERAMIC MELF	0.33uF 5% 50V
C43	1-163-059-00	CERAMIC MELF	0.01uF 20% 16V	C100	1-124-443-00	ELECT	100uF 20% 10V
C44	1-123-382-00	ELECT	3.3uF 20% 100V	C101	1-164-159-11	CERAMIC	0.1uF 50V
C45	1-161-375-00	CERAMIC CHIP	0.0022uF 20% 25V	C111	1-124-257-00	ELECT	2.2uF 20% 50V
C46	1-123-382-00	ELECT	3.3uF 20% 50V	C112	1-124-463-00	ELECT	0.1uF 20% 50V
C47	1-161-375-00	CERAMIC CHIP	0.0022uF 20% 25V	C113	1-163-059-00	CERAMIC MELF	0.01uF 20% 16V
C48	1-124-477-11	ELECT	47uF 20% 16V	C114	1-124-477-11	ELECT	47uF 20% 16V
				C115	1-124-254-00	ELECT	0.68uF 20% 50V

TUNER

Ref. No.	Part No.	Description	Remark
C116	1-163-059-00	CERAMIC MELF 0.01uF	20% 16V
		< FILTER >	
CF1	1-567-389-11	FILTER, CERAMIC	
CF2	1-567-389-11	FILTER, CERAMIC	
		< OSCILLATOR >	
CF21	1-577-075-11	OSCILLATOR, CERAMIC	
		< IF TRANSFORMER >	
CFT21	1-404-853-11	TRANSFORMER, IF (CERAMIC FILTER)	
		< CONECTOR >	
* CNJ1	1-564-342-11	SOCKET, CONNECTOR 8P	
* CNJ2	1-564-339-00	PIN, CONNECTOR 5P	
* CNJ3	1-564-341-11	PIN, CONNECTOR 7P	
* CNJ4	1-564-337-00	PIN, CONNECTOR 3P	
		< TRIMMER >	
CT61	1-141-227-00	CAP, TRIMMER	
CT62	1-141-227-00	CAP, TRIMMER	
CT63	1-141-227-00	CAP, TRIMMER	
CT64	1-141-227-00	CAP, TRIMMER	
		< DIODE >	
D61	8-719-903-27	DIODE 1SS168	
D62	8-719-903-27	DIODE 1SS168	
D63	8-719-903-27	DIODE 1SS168	
D64	8-719-903-27	DIODE 1SS168	
D65	8-719-903-27	DIODE 1SS168	
D66	8-719-903-27	DIODE 1SS168	
D67	8-719-903-27	DIODE 1SS168	
D68	8-719-903-27	DIODE 1SS168	
D69	8-719-903-27	DIODE 1SS168	
D70	8-719-903-27	DIODE 1SS168	
D71	8-719-903-27	DIODE 1SS168	
D72	8-719-903-27	DIODE 1SS168	
D73	8-719-903-27	DIODE 1SS168	
D74	8-719-903-27	DIODE 1SS168	
D75	8-719-903-27	DIODE 1SS168	
D76	8-719-903-27	DIODE 1SS168	
D77	8-719-903-27	DIODE 1SS168	
		< FM FRONT END >	
FE1	1-463-862-21	FRONT END, FM	

Ref. No.	Part No.	Description	Remark
		< ENCAPSULATED COMPONENT >	
FE61	1-236-514-11	ENCAPSULATED COMPONENT	
		< IC >	
IC21	8-759-821-45	IC LA1851N	
IC91	8-759-820-91	IC LC7218	
		< INDUCTOR >	
L1	1-410-521-11	MICRO INDUCTOR 100uH	
L21	1-410-171-11	MICRO INDUCTOR 1mH	
L22	1-410-518-41	MICRO INDUCTOR 56uH	
L61	1-410-171-11	MICRO INDUCTOR 1mH	
L62	1-410-171-11	MICRO INDUCTOR 1mH	
L63	1-410-624-11	MICRO INDUCTOR 560uH	
L64	1-410-624-11	MICRO INDUCTOR 560uH	
L65	1-410-624-11	MICRO INDUCTOR 560uH	
L66	1-410-624-11	MICRO INDUCTOR 560uH	
L67	1-410-624-11	MICRO INDUCTOR 560uH	
L68	1-410-624-11	MICRO INDUCTOR 560uH	
		< LOW PASS FILTER >	
LPF21	1-235-164-00	FILTER, LOW PASS	
LPF22	1-235-164-00	FILTER, LOW PASS	
		< TRANSISTOR >	
Q1	8-729-230-99	TRANSISTOR 2SC2669-0Y	
Q2	8-729-230-99	TRANSISTOR 2SC2669-0Y	
Q21	8-729-820-24	TRANSISTOR 2SC3330-T	
Q22	8-729-820-24	TRANSISTOR 2SC3330-T	
Q23	8-729-900-61	TRANSISTOR DTA114ES	
Q24	8-729-900-80	TRANSISTOR DTC114ES	
Q25	8-729-900-80	TRANSISTOR DTC114ES	
Q61	8-729-900-80	TRANSISTOR DTC114ES	
Q62	8-729-900-80	TRANSISTOR DTC114ES	
Q63	8-729-900-80	TRANSISTOR DTC114ES	
Q64	8-729-900-61	TRANSISTOR DTA114ES	
Q65	8-729-900-61	TRANSISTOR DTA114ES	
Q91	8-729-900-61	TRANSISTOR DTA114ES	
Q92	8-729-900-80	TRANSISTOR DTC114ES	
Q111	8-729-202-67	TRANSISTOR 2SK246-GR3	
Q112	8-729-230-93	TRANSISTOR 2SC3113-AB	
Q113	8-729-202-67	TRANSISTOR 2SK246-GR3	
Q114	8-729-230-93	TRANSISTOR 2SC3113-AB	
		< RESISTOR >	
△R1	1-249-401-11	CARBON (SMALL) 47 5%	1/4W F
R2	1-249-329-11	CARBON MELF 330 5%	1/8W

The components identified by mark △ or dotted line with mark △ are critical for safety. Replace only with part number specified.

TUNER

Ref. No.	Part No.	Description	Remark			Ref. No.	Part No.	Description	Remark		
R3	1-249-329-11	CARBON MELF	330	5%	1/8W	R91	1-249-335-11	CARBON MELF	1K	5%	1/8W
R4	1-249-329-11	CARBON MELF	330	5%	1/8W	R92	1-249-335-11	CARBON MELF	1K	5%	1/8W
R5	1-249-329-11	CARBON MELF	330	5%	1/8W	R93	1-249-335-11	CARBON MELF	1K	5%	1/8W
R6	1-249-350-11	CARBON MELF	18K	5%	1/8W	R94	1-249-335-11	CARBON MELF	1K	5%	1/8W
R7	1-249-329-11	CARBON MELF	330	5%	1/8W	R95	1-249-347-11	CARBON MELF	10K	5%	1/8W
R8	1-249-332-11	CARBON MELF	560	5%	1/8W	R96	1-249-335-11	CARBON MELF	1K	5%	1/8W
R9	1-249-352-11	CARBON MELF	27K	5%	1/8W	R97	1-249-347-11	CARBON MELF	10K	5%	1/8W
△R21	1-249-404-00	CARBON (SMALL)	82	5%	1/4W F	R98	1-249-343-11	CARBON MELF	4.7K	5%	1/8W
R22	1-249-433-11	CARBON (SMALL)	22K	5%	1/4W	R99	1-249-335-11	CARBON MELF	1K	5%	1/8W
R23	1-249-335-11	CARBON MELF	1K	5%	1/8W	R100	1-249-335-11	CARBON MELF	1K	5%	1/8W
R24	1-249-340-11	CARBON MELF	2.7K	5%	1/8W	△R101	1-249-401-11	CARBON (SMALL)	47	5%	1/4W F
R25	1-249-346-11	CARBON MELF	8.2K	5%	1/8W	R111	1-249-341-11	CARBON MELF	3.3K	5%	1/8W
R26	1-249-350-11	CARBON MELF	18K	5%	1/8W	R112	1-249-332-11	CARBON MELF	560	5%	1/8W
R27	1-249-423-11	CARBON (SMALL)	3.3K	5%	1/4W	R113	1-249-335-11	CARBON MELF	1K	5%	1/8W
R28	1-249-347-11	CARBON MELF	10K	5%	1/8W	R114	1-249-328-11	CARBON MELF	270	5%	1/8W
R30	1-249-331-11	CARBON MELF	470	5%	1/8W	R115	1-249-343-11	CARBON MELF	4.7K	5%	1/8W
R31	1-249-347-11	CARBON MELF	10K	5%	1/8W	R116	1-249-339-11	CARBON MELF	2.2K	5%	1/8W
R32	1-249-347-11	CARBON MELF	10K	5%	1/8W	R117	1-249-343-11	CARBON MELF	4.7K	5%	1/8W
△R33	1-249-437-11	CARBON (SMALL)	47K	5%	1/4W F	R118	1-249-323-11	CARBON MELF	100	5%	1/8W
R34	1-249-355-11	CARBON MELF	47K	5%	1/8W	△R119	1-249-405-11	CARBON (SMALL)	100	5%	1/4W F
R35	1-249-365-11	CARBON MELF	330	5%	1/8W	R120	1-249-353-11	CARBON MELF	33K	5%	1/8W
R36	1-249-339-11	CARBON MELF	2.2K	5%	1/8W	R121	1-249-332-11	CARBON MELF	560	5%	1/8W
R37	1-249-338-11	CARBON MELF	1.8K	5%	1/8W	R122	1-249-335-11	CARBON MELF	1K	5%	1/8W
R38	1-249-365-11	CARBON MELF	330	5%	1/8W	R123	1-249-328-11	CARBON MELF	270	5%	1/8W
R39	1-249-339-11	CARBON MELF	2.2K	5%	1/8W	R124	1-249-347-11	CARBON MELF	10K	5%	1/8W
R40	1-249-338-11	CARBON MELF	1.8K	5%	1/8W	R125	1-249-339-11	CARBON MELF	2.2K	5%	1/8W
R41	1-249-344-11	CARBON MELF	5.6K	5%	1/8W	R126	1-249-343-11	CARBON MELF	4.7K	5%	1/8W
R42	1-249-344-11	CARBON MELF	5.6K	5%	1/8W	R127	1-249-323-11	CARBON MELF	100	5%	1/8W
△R43	1-249-409-11	CARBON (SMALL)	220	5%	1/4W F						
R61	1-249-347-11	CARBON MELF	10K	5%	1/8W			< VARIABLE RESISTOR >			
R62	1-249-347-11	CARBON MELF	10K	5%	1/8W	RV21	1-238-598-11	RES, ADJ, CARBON 2.2K			
R63	1-249-331-11	CARBON MELF	470	5%	1/8W	RV22	1-238-601-11	RES, ADJ, CARBON 22K			
R64	1-249-354-11	CARBON MELF	39K	5%	1/8W	RV23	1-238-601-11	RES, ADJ, CARBON 22K			
R65	1-249-359-11	CARBON MELF	100K	5%	1/8W			< TRANSFORMER >			
R66	1-249-355-11	CARBON MELF	47K	5%	1/8W	T21	1-404-807-11	TRANSFORMER, DISCRIMINATOR			
R67	1-249-343-11	CARBON MELF	4.7K	5%	1/8W	T61	1-402-447-11	COIL (ANT SW 1)			
R68	1-249-319-11	CARBON MELF	47	5%	1/8W	T62	1-406-354-11	COIL (OSC SW 1)			
R70	1-249-353-11	CARBON MELF	33K	5%	1/8W	T63	1-402-448-11	COIL (ANT SW 2)			
R71	1-249-353-11	CARBON MELF	33K	5%	1/8W	T64	1-406-346-11	COIL (OSC SW 2)			
R72	1-249-340-11	CARBON MELF	2.7K	5%	1/8W			< TERMINAL >			
R73	1-249-340-11	CARBON MELF	2.7K	5%	1/8W	* TM1	1-537-238-21	TERMINAL BOARD (ANTENNA)			
R74	1-249-343-11	CARBON MELF	4.7K	5%	1/8W			< CONNECTOR PIN >			
R76	1-249-353-11	CARBON MELF	33K	5%	1/8W	* TP1	1-560-060-00	PIN, CONNECTOR 2P			
R77	1-249-353-11	CARBON MELF	33K	5%	1/8W						
R78	1-249-340-11	CARBON MELF	2.7K	5%	1/8W						
R79	1-249-359-11	CARBON MELF	100K	5%	1/8W						
R80	1-249-355-11	CARBON MELF	47K	5%	1/8W						
R81	1-249-338-11	CARBON MELF	1.8K	5%	1/8W						
R82	1-249-343-11	CARBON MELF	4.7K	5%	1/8W						

The components identified by mark △ or dotted line with mark △ are critical for safety. Replace only with part number specified.

TUNER

DISPLAY

CONNECTOR

Ref. No.	Part No.	Description	Remark
		< CRYSTAL VIBRATOR >	
XT91	1-577-126-11	VIBRATOR, CRYSTAL (7.2MHz)	

*	A-4345-968-A	DISPLAY BOARD, COMPLETE	

*	1-643-554-11	CONNECTOR BOARD	

*	4-932-810-11	CUSHION (FL)	
*	4-944-441-01	HOLDER (FL TUBE)	
		< CAPACITOR >	
C601	1-124-471-00	ELECT	1000uF 20% 6.3V
C610	1-124-907-11	ELECT	10uF 20% 50V
C701	1-126-177-11	ELECT	100uF 20% 10V
C702	1-164-159-11	CERAMIC	0.1uF 50V
C704	1-124-463-00	ELECT	0.1uF 20% 50V
C705	1-161-494-00	CERAMIC	0.022uF 25V
C706	1-162-198-31	CERAMIC	8.2PF 10% 50V
C707	1-162-198-31	CERAMIC	8.2PF 10% 50V
C710	1-164-159-11	CERAMIC	0.1uF 50V
C711	1-126-157-11	ELECT	10uF 20% 16V
C712	1-126-177-11	ELECT	100uF 20% 10V
C713	1-136-173-00	FILM	0.47uF 5% 50V
C714	1-136-173-00	FILM	0.47uF 5% 50V
C715	1-136-173-00	FILM	0.47uF 5% 50V
C716	1-161-494-00	CERAMIC	0.022uF 25V
C719	1-162-306-11	CERAMIC	0.01uF 20% 16V
C720	1-162-306-11	CERAMIC	0.01uF 20% 16V
		< VIBRATOR >	
CF701	1-579-125-11	VIBRATOR, CERAMIC (8MHz)	
		< CONNECTOR >	
* CNJ601	1-566-859-11	SOCKET, CONNECTOR 15P (SYSTEM CONTROL1)	
* CNJ602	1-564-341-11	PIN, CONNECTOR 7P	
* CNJ603	1-564-337-00	PIN, CONNECTOR 3P	
* CNJ604	1-565-561-11	PIN, CONNECTOR 3P (AU BUS)	
* CNJ701	1-564-342-11	PIN, CONNECTOR 8P	
* CNJ702	1-564-339-00	PIN, CONNECTOR 5P	
		< DIODE >	
D701	8-719-987-63	DIODE	1N4148M
D702	8-719-987-63	DIODE	1N4148M
D708	8-719-987-63	DIODE	1N4148M
D710	8-719-301-39	LED	SEL2210S-D (PRESET)
D711	8-719-301-39	LED	SEL2210S-D (TUNING)

Ref. No.	Part No.	Description	Remark
D712	8-719-987-63	DIODE	1N4148M
D714	8-719-987-63	DIODE	1N4148M
D715	8-719-010-28	DIODE	UZ-4.3BSA
D716	8-719-987-63	DIODE	1N4148M
D717	8-719-987-63	DIODE	1N4148M
D718	8-719-987-63	DIODE	1N4148M
		< FLUORESCENT INDICATOR >	
FLT701	1-519-709-11	INDICATOR TUBE, FLUORESCENT	
		< IC >	
IC701	8-759-059-85	IC	TMP87CC70F
IC702	8-759-500-31	IC	X24C01P
IC703	8-749-920-83	IC	GP1U52XB
IC704	8-759-515-58	IC	PST572H
		< COIL >	
L701	1-410-521-11	INDUCTOR	100uH
L702	1-410-521-11	INDUCTOR	100uH
		< TRANSISTOR >	
Q701	8-729-900-80	TRANSISTOR	DTC114ES
Q702	8-729-900-80	TRANSISTOR	DTC114ES
Q705	8-729-119-76	TRANSISTOR	2SA1175-HFE
Q706	8-729-900-80	TRANSISTOR	DTC114ES
Q707	8-729-620-05	TRANSISTOR	2SC2603-EF
		< RESISTOR >	
R601	1-249-393-11	CARBON	10 5% 1/4W
R701	1-249-417-11	CARBON	1K 5% 1/4W
R702	1-249-417-11	CARBON	1K 5% 1/4W
R703	1-249-417-11	CARBON	1K 5% 1/4W
R704	1-249-417-11	CARBON	1K 5% 1/4W
R705	1-249-417-11	CARBON	1K 5% 1/4W
R706	1-249-423-11	CARBON	3.3K 5% 1/4W
R707	1-249-423-11	CARBON	3.3K 5% 1/4W
R708	1-249-421-11	CARBON	2.2K 5% 1/4W
R709	1-249-423-11	CARBON	3.3K 5% 1/4W
R710	1-249-429-11	CARBON	10K 5% 1/4W
R711	1-249-429-11	CARBON	10K 5% 1/4W
R712	1-249-411-11	CARBON	330 5% 1/4W
R714	1-249-429-11	CARBON	10K 5% 1/4W
R715	1-249-417-11	CARBON	1K 5% 1/4W
R716	1-249-429-11	CARBON	10K 5% 1/4W
R717	1-249-425-11	CARBON	4.7K 5% 1/4W
R718	1-249-429-11	CARBON	10K 5% 1/4W
R719	1-249-429-11	CARBON	10K 5% 1/4W
R720	1-249-429-11	CARBON	10K 5% 1/4W

DISPLAY

CONNECTOR

Ref.No.	Part No.	Description			Remark
R721	1-249-429-11	CARBON	10K	5%	1/4W
R722	1-249-429-11	CARBON	10K	5%	1/4W
R723	1-249-423-11	CARBON	3.3K	5%	1/4W
R724	1-249-429-11	CARBON	10K	5%	1/4W
R725	1-249-417-11	CARBON	1K	5%	1/4W
R726	1-249-417-11	CARBON	1K	5%	1/4W
R727	1-249-417-11	CARBON	1K	5%	1/4W
R728	1-249-417-11	CARBON	1K	5%	1/4W
R729	1-249-417-11	CARBON	1K	5%	1/4W
R730	1-249-417-11	CARBON	1K	5%	1/4W
R731	1-249-429-11	CARBON	10K	5%	1/4W
R732	1-249-429-11	CARBON	10K	5%	1/4W
R733	1-249-429-11	CARBON	10K	5%	1/4W
R734	1-249-417-11	CARBON	1K	5%	1/4W
R736	1-249-429-11	CARBON	10K	5%	1/4W
R737	1-249-409-11	CARBON	220	5%	1/4W
< SWITCH >					
S701	1-554-303-21	SWITCH, TACTILE	(WAKE UP TIMER 1)		
S702	1-554-303-21	SWITCH, TACTILE	(WAKE UP TIMER 2)		
S703	1-554-303-21	SWITCH, TACTILE	(REC TIMER)		
S705	1-554-303-21	SWITCH, TACTILE	(MEMORY/NEXT)		
S706	1-554-303-21	SWITCH, TACTILE	(MODE)		
S707	1-554-303-21	SWITCH, TACTILE	(STEREO/MONO)		
S708	1-554-303-21	SWITCH, TACTILE	(BAND)		
S709	1-554-303-21	SWITCH, TACTILE	(-)		
S710	1-554-303-21	SWITCH, TACTILE	(+))		
< VIBRATOR >					
XT701	1-527-997-21	VIBRATOR, CRYSTAL	(32KHz)		
